

South Shore Soccer League Playoffs 2019 Finals Schedule - Bridgewater - June 16, 2019

Last updated:
6/15/19 6:48 PM

| | | Field 1 | Field 2 | Field 3 | Field 4 | Field 5 | Field 6 | |
|-------------------------------------|----------------|---------------|------------------|--------------|-------------------|--------------|---------------|--|
| 8 : 3 0 A M | G8.1 | W | B8.1 | G10.1 | W | B12.1 | W | |
| | WEY (Reilly) | | BRK (Veiga) | | BRG (Berry) | | EBG (Floeck) | |
| | versus | | 49 | versus | | 50 | versus | |
| | | EAS (Pereira) | EAS (Kilmartin) | | EAS (Gibson) | | ABG (Molloy) | |
| 9 : 0 0 A M | B6.1 | | B8.3 | G12.1 | W | B6.2 | G6.2 | |
| | BRA (Smith) | | RAN (Prenelus) | | RAY (Daryanani) | | WBG (Morash) | |
| | versus | | 53 | versus | | 58 | versus | |
| | | QNY (Mergel) | MMR (Modracek) | | BRA (Giannandrea) | | HAN (Chapman) | |
| 1 0 : 3 0 A M | G8.3 | | B8.2 | G12.2 | | G6.1 | G6.3 | |
| | BRK (Olmstead) | | MMR (Wyman) | | BRK (Shaw) | | MMR (Feeney) | |
| | versus | | 55 | versus | | 63 | versus | |
| | | WEY1 (Fisher) | EBG (Mesheau) | | RAN (Taveira) | | EAS (Barth) | |
| 1 2 : 3 0 P M | G8.2 | | B10.1 | G12.1 | | G6.1 | B6.3 | |
| | BRA (Firicano) | | WBG (Shamey) | | WBG (Shamey) | | WBG (Maher) | |
| | versus | | 61 | versus | | 64 | versus | |
| | | WBG (Gately) | WEY (O'Halloran) | | WEY (Fuller) | | SHA (Scarfo) | |

W - MTOC Wild Card Division

Over-time or
PK winner ==>

Over-time or
PK winner ==>



South Shore Soccer League Playoffs 2019 Semi Finals Schedule - Bridgewater - June 15, 2019

Last updated:
6/15/19 6:48 PM

| Field 4 | | Field 3 | | Field 2 | | Field 1 | | Field 5 | | Field 6 | | | | | | | | | | |
|--|------------------|----------------|-------------------|------------------|------------------|---------|--|-----------------|----------------|-----------------|-----------------|--------------------------------|-------------|--|-----------------|------------------|---|-----------------|---------------|---|
| 8 : 0 0 A M | B12.1 - 1st Seed | EBG (Floeck) | 3 | B12.1 - 2nd Seed | BRG (Davis) | 0 | 8 : 3 0 A M | B8.1 - 1st Seed | BRK (Veiga) | 4 | B8.1 - 2nd Seed | WEY (McLeod) | 1 | 8 : 0 0 A M | B6.1 - 1st Seed | BRA (Smith) | 8 | B6.1 - 2nd Seed | BRK (Fontes) | 2 |
| | B12.1 - 4th Seed | 17 | B12.1 - 3rd Seed | 18 | B8.1 - 4th Seed | 19 | | B8.1 - 3rd Seed | 20 | B6.1 - 4th Seed | 21 | B6.1 - 3rd Seed | 22 | | | | | | | |
| | QNY (Hassan) | 0 | ABG (Molloy) | 1 | SHA (Cura) | 0 | | EAS (Kilmartin) | 3 | ACU (Nunes) | 1 | QNY (Mergel) | 3 | | | | | | | |
| 1 : 0 0 0 A M | B10.1 - 1st Seed | WBG (Shamey) | 6 | B10.1 - 2nd Seed | WEY (O'Halloran) | 3 | 1 : 0 1 5 A M | G8.1 - 1st Seed | WEY (Reilly) | 3 | G8.1 - 2nd Seed | EAS (Pereira) | 5 | 9 : 3 0 A M | G6.2 - 1st Seed | WHT (Fitzgerald) | 0 | G6.2 - 2nd Seed | HAN (Chapman) | 3 |
| | B10.1 - 4th Seed | 23 | B10.1 - 3rd Seed | 24 | G8.1 - 4th Seed | 25 | | G8.1 - 3rd Seed | 26 | G6.2 - 4th Seed | 27 | G6.2 - 3rd Seed | 28 | | | | | | | |
| | WHT (Allen) | 1 | BRG (Trombley) | 1 | QNY (Gola) | 0 | | BRA (Wilson) | 4 | WBG (Morash) | 4 | BRA (Ranieri) | 2 | | | | | | | |
| 1 : 2 : 0 0 P M | G12.1 - 1st Seed | HOL (Cochran) | 0 | G12.1 - 2nd Seed | BRG (Barron) | 3 | 1 : 2 : 0 0 P M | G8.3 - 1st Seed | EAS (DiPietro) | 0 | G8.3 - 2nd Seed | BRK (Olmstead) | 6 | 1 : 1 : 0 0 A M | B6.2 - 2nd Seed | WHT (Murray) | 5 | B6.2 - 1st Seed | ABG (Grafton) | 0 |
| | G12.1 - 4th Seed | 29 | G12.1 - 3rd Seed | 30 | G8.3 - 4th Seed | 31 | | G8.3 - 3rd Seed | 32 | B6.2 - 3rd Seed | 33 | B6.2 - 4th Seed | 34 | | | | | | | |
| | RAY (Daryanani) | 4 | BRA (Giannandrea) | 4 | WEY1 (Fisher) | 2 | | QNY (Sampson) | 0 | EBG (McCarthy) | 1 | RCK (Harlow) | 2 | | | | | | | |
| 2 : 0 0 P M | G10.1 - 2nd Seed | EBG (Chisholm) | 2 | G8.2 - 1st Seed | BRK (Nieves) | 1 | 1 : 4 5 P M | B8.3 - 2nd Seed | MMR (Modracek) | 3 | B8.3 - 1st Seed | RAN (Prenelus) | 6 | 1 : 0 0 P M | G6.3 - 1st Seed | MMR (Feeney) | 7 | G6.3 - 2nd Seed | STO (Smith) | 0 |
| | G10.1 - 3rd Seed | 35 | G8.2 - 4th Seed | 36 | B8.3 - 3rd Seed | 37 | | B8.3 - 4th Seed | 38 | G6.3 - 4th Seed | 39 | G6.3 - 3rd Seed | 40 | | | | | | | |
| | EAS (Gibson) | 7 | BRA (Firicano) | 4 | QNY (Johnston) | 1 | | RCK (Comman) | 1 | QNY (Cary) | 0 | EAS (Barth) | 1 | | | | | | | |
| 4 : 0 0 P M | G8.2 - 2nd Seed | WBG (Gately) | 3 | G10.1 - 1st Seed | BRG (Berry) | 1 | 3 : 3 0 P M | B8.2 - 1st Seed | MMR (Wyman) | 1 | B8.2 - 2nd Seed | ACU (Macaroco) | 0 | 2 : 3 0 P M | B6.3 - 1st Seed | WBG (Maher) | 3 | B6.3 - 2nd Seed | BRA2 (Romero) | 2 |
| | G8.2 - 3rd Seed | 41 | G10.1 - 4th Seed | 42 | B8.2 - 4th Seed | 43 | | B8.2 - 3rd Seed | 44 | B6.3 - 4th Seed | 45 | B6.3 - 3rd Seed | 46 | | | | | | | |
| | SHA (Soby) | 2 | BYE | 0 | BYE | 0 | | EBG (Mesheau) | 1 | QNY (Cavicchi) | 2 | SHA (Scarfo) | 9 | | | | | | | |
| 4 : 0 0 P M | G6.1 - 2nd Seed | WEY (Fuller) | 2 | G6.1 - 1st Seed | BRA (O'Sullivan) | 10 | 4 : 0 0 P M | G6.1 - 3rd Seed | 47 | G6.1 - 4th Seed | 48 | 4 : 0 0 P M | BRG (Smith) | 1 | STO (Fox) | 1 | | | | |

Over-time or
PK winner ==> 

South Shore Soccer League Playoffs 2019

Quarter Finals Schedule - Raynham - June 8, 2019

Last updated:
6/15/19 6:48 PM

Field 2

| | | |
|--------------------------------|--------------------|----------|
| 8 : 3 0 A M | B6.2 Seed 1 | |
| | ABG (Grafton) | 3 |
| | B6.2 Seed 8 | 1 |
| | ACU (Borges) | 0 |

Field 4

| | | |
|--|--------------------|----------|
| | G6.2 Seed 1 | |
| | WHT (Fitzgerald) | 4 |
| | G6.2 Seed 8 | 2 |
| | MMR (Cardinal) | 1 |

Field

Field 1

| | | |
|--------------------------------|--------------------|----------|
| 9 : 0 0 A M | G8.2 Seed 1 | |
| | RCK (Proctor) | 1 |
| | G8.2 Seed 8 | 3 |
| | BRK (Nieves) | 2 |

Field 3

| | | |
|--|--------------------|----------|
| | B8.2 Seed 2 | |
| | MMR (Wyman) | 8 |
| | B8.2 Seed 7 | 4 |
| | HOL (Clark) | 1 |

| | | |
|-------------------------------------|--------------------|----------|
| 1 0 : 0 0 A M | B6.2 Seed 2 | |
| | WHT (Murray) | 5 |
| | B6.2 Seed 7 | 5 |
| | RAN (Myrthil) | 4 |

| | | |
|--|--------------------|----------|
| | G6.2 Seed 2 | |
| | HAN (Chapman) | 5 |
| | G6.2 Seed 7 | 6 |
| | BRG (Beane) | 0 |

| | | |
|-------------------------------------|--------------------|----------|
| 1 0 : 3 0 A M | G8.2 Seed 2 | |
| | WBG (Gately) | 5 |
| | G8.2 Seed 7 | 7 |
| | EAS (Schwarz) | 0 |

| | | |
|--|------------------------|----------|
| | B8.2 Seed 4 | |
| | EBG (Mesheau) | 4 |
| | B8.2 Seed 5 | 8 |
| | WBG (Santiago-Calling) | 3 |

| | | |
|-------------------------------------|--------------------|----------|
| 1 1 : 3 0 A M | B6.2 Seed 4 | |
| | RCK (Harlow) | 5 |
| | B6.2 Seed 5 | 9 |
| | RCK (Comman) | 1 |

| | | |
|--|--------------------|-----------|
| | G6.2 Seed 4 | |
| | RCK (Hennessy) | 0 |
| | G6.2 Seed 5 | 10 |
| | WBG (Morash) | 4 |

| | | |
|-------------------------------------|--------------------|-----------|
| 1 2 : 3 0 P M | G8.2 Seed 4 | |
| | WHT (Frank) | 0 |
| | G8.2 Seed 5 | 11 |
| | BRA (Firicano) | 3 |

| | | |
|--|--------------------|-----------|
| | B8.2 Seed 3 | A |
| | ABG (Spinney) | 0 |
| | B8.2 Seed 6 | 12 |
| | ACU (Macaroco) | 1 |

| | | |
|--------------------------------|--------------------|-----------|
| 1 : 0 0 P M | B6.2 Seed 3 | |
| | EBG (McCarthy) | 5 |
| | B6.2 Seed 6 | 13 |
| | RAY (Beckwith) | 1 |

| | | |
|--|--------------------|-----------|
| | G6.2 Seed 3 | |
| | EAS (Gamble) | 2 |
| | G6.2 Seed 6 | 14 |
| | BRA (Ranieri) | 5 |

| | | |
|--------------------------------|--------------------|-----------|
| 2 : 0 0 P M | G8.2 Seed 3 | B |
| | SHA (Soby) | 2 |
| | G8.2 Seed 6 | 15 |
| | STO (Durand) | 0 |

| | | |
|--|--------------------|-----------|
| | B8.2 Seed 1 | C |
| | QNY (Bridges) | 5 |
| | B8.2 Seed 8 | 16 |
| | STO (Teixeira) | 0 |

A Game to be played in Abington on Sunday 6/9 @ 10:00 AM
B Game to be played in Sharon on Friday 6/7 @ 6:00 PM
C Game to be played in Quincy on Thursday 6/13 @ 8:15 PM

| | |
|-------------|--------------|
| Seed | B12.1 |
|-------------|--------------|

- 1 EBG (Floeck)
- 2 BRG (Davis)
- 3 ABG (Molloy)
- 4 QNY (Hassan)

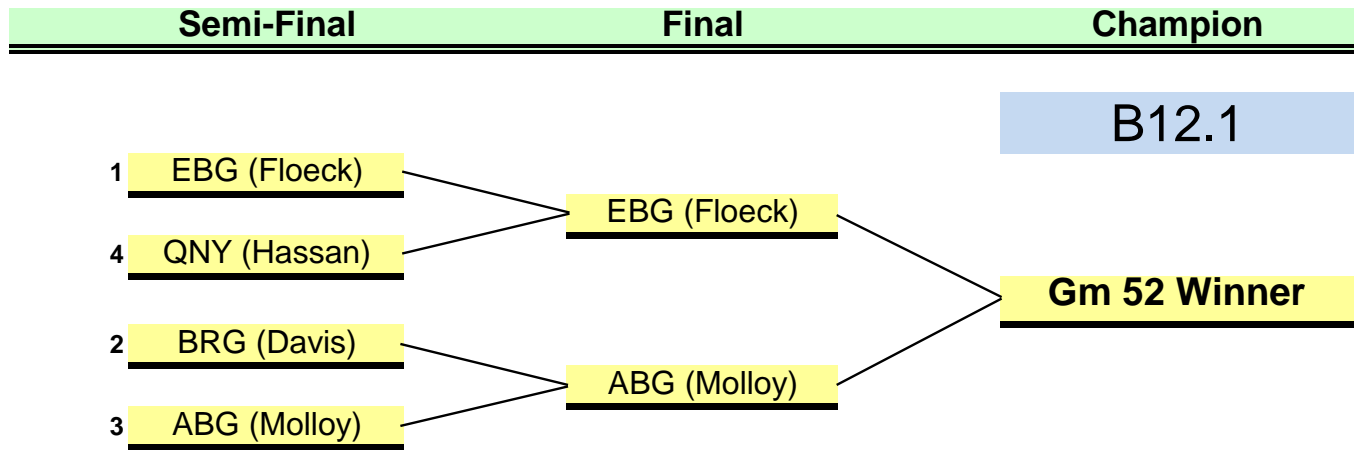

Seeds to be determined by Total Points

| | |
|-------------|--------------|
| Seed | B12.2 |
|-------------|--------------|

- 1 RCK (Cleaves)
- 2 EAS (Goldman)
- 3 placeholder
- 4 ABG (Molloy)

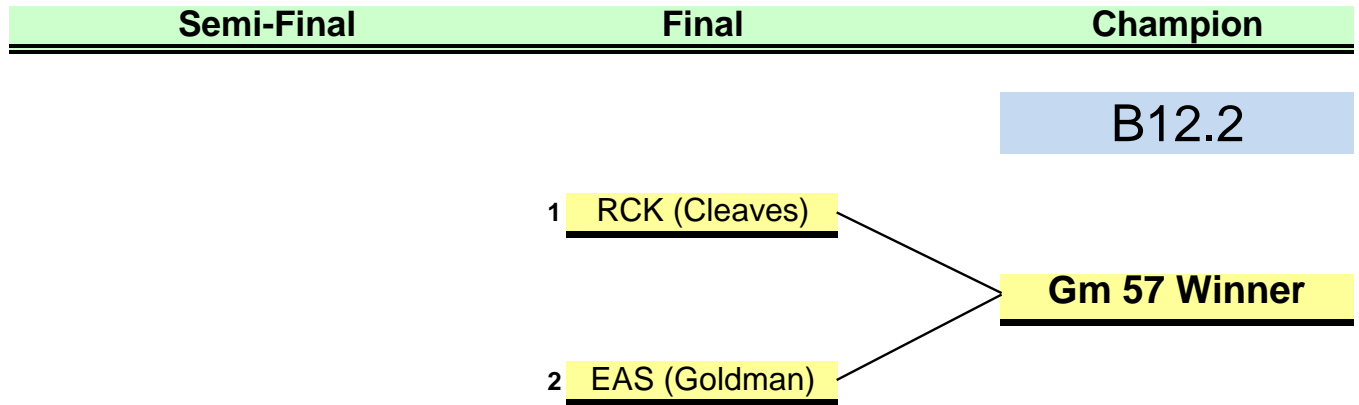

Seeds to be determined by Total Points

Last Updated: 6/15/19 6:48 PM

| Seed | G12.1 |
|------|-------|
|------|-------|

- 1 HOL (Cochran)
- 2 BRG (Barron)
- 3 BRA (Giannandrea)
- 4 RAY (Daryanani)

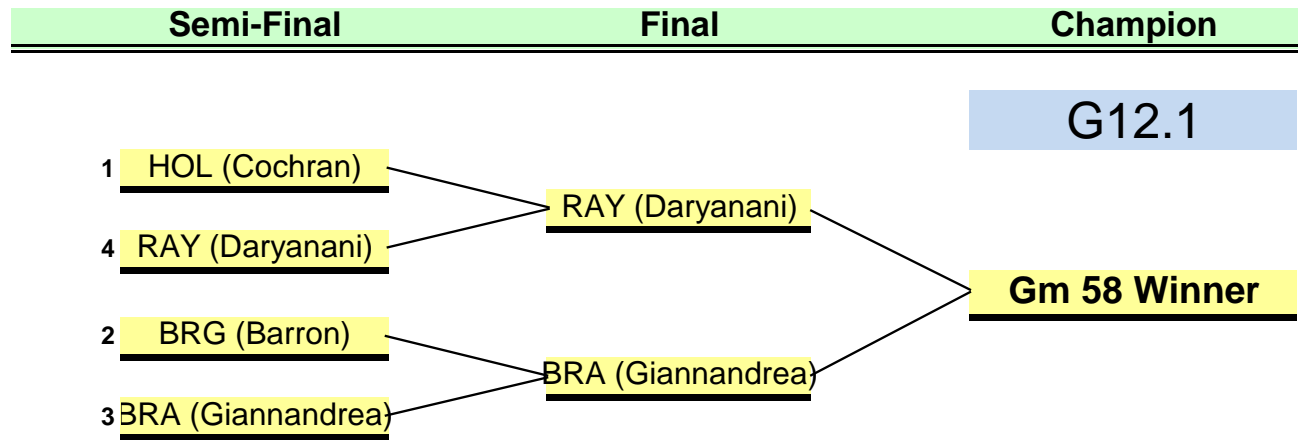

Seeds to be determined by Total Points

| Seed | G12.2 |
|------|-------|
|------|-------|

- 1 BRK (Shaw)
- 2 RAN (Taveira)
- 3 ABG (Groom)
- 4 ACU (Garcia Jr)

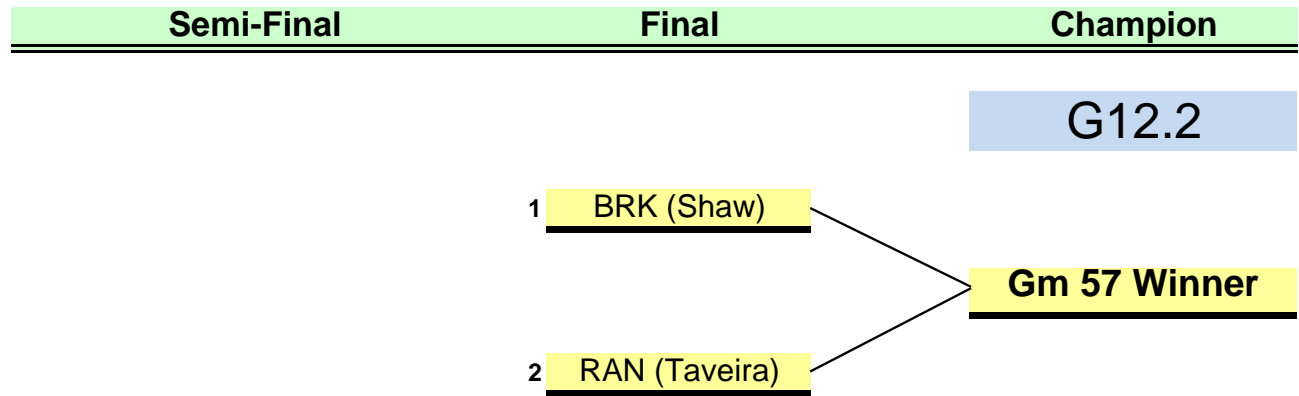

Seeds to be determined by Total Points

Last Updated: 6/15/19 6:48 PM

| | |
|-------------|--------------|
| Seed | B10.1 |
|-------------|--------------|

- 1 WBG (Shamey)
- 2 WEY (O'Halloran)
- 3 BRG (Trombley)
- 4 WHT (Allen)

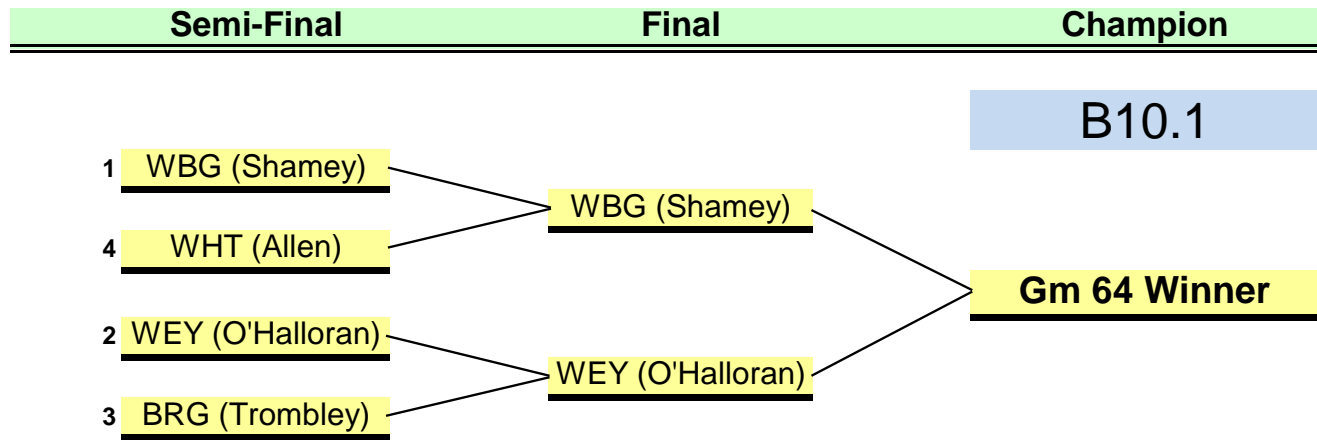

Seeds to be determined by Total Points



| Seed | G10.1 |
|------|-------|
|------|-------|

- 1 BRG (Berry)
- 2 EBG (Chisholm)
- 3 EAS (Gibson)
- 4 BYE

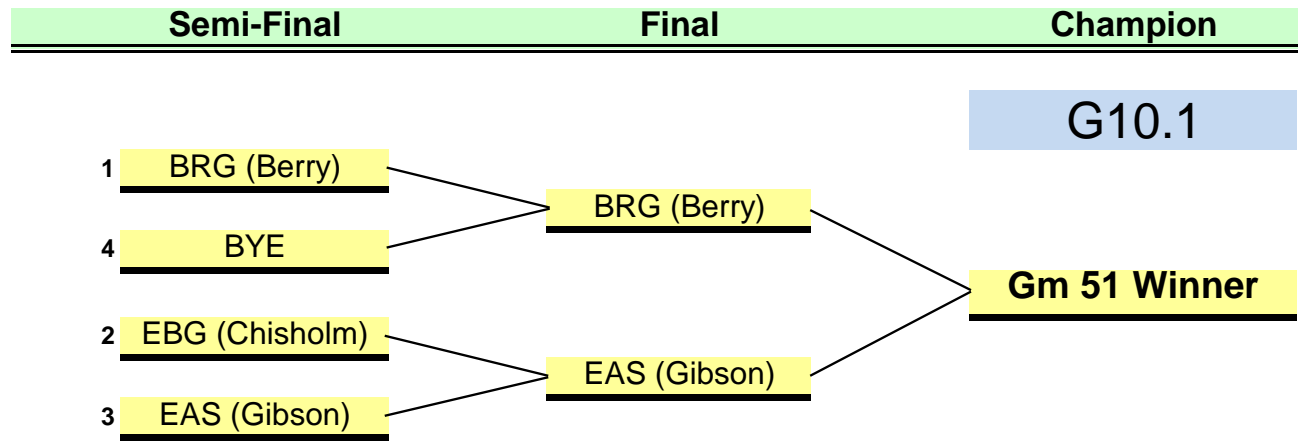

Seeds to be determined by Total Points



| | |
|-------------|-------------|
| Seed | B8.1 |
|-------------|-------------|

- 1 BRK (Veiga)
- 2 WEY (McLeod)
- 3 EAS (Kilmartin)
- 4 SHA (Cura)

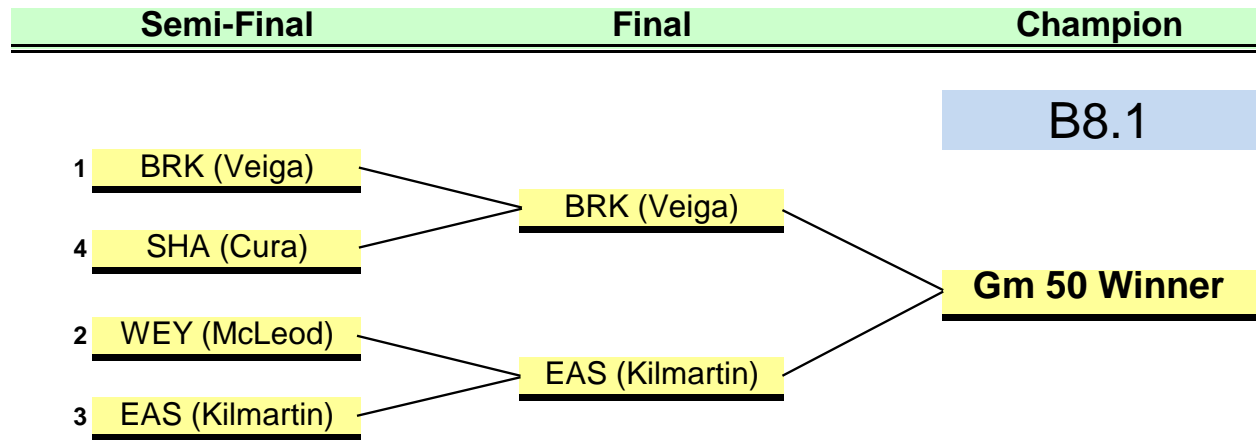

Seeds to be determined by Total Points

| | |
|-------------|-------------|
| Seed | B8.3 |
|-------------|-------------|

- 1 RAN (Prenelus)
- 2 MMR (Modracek)
- 3 QNY (Johnston)
- 4 RCK (Comman)

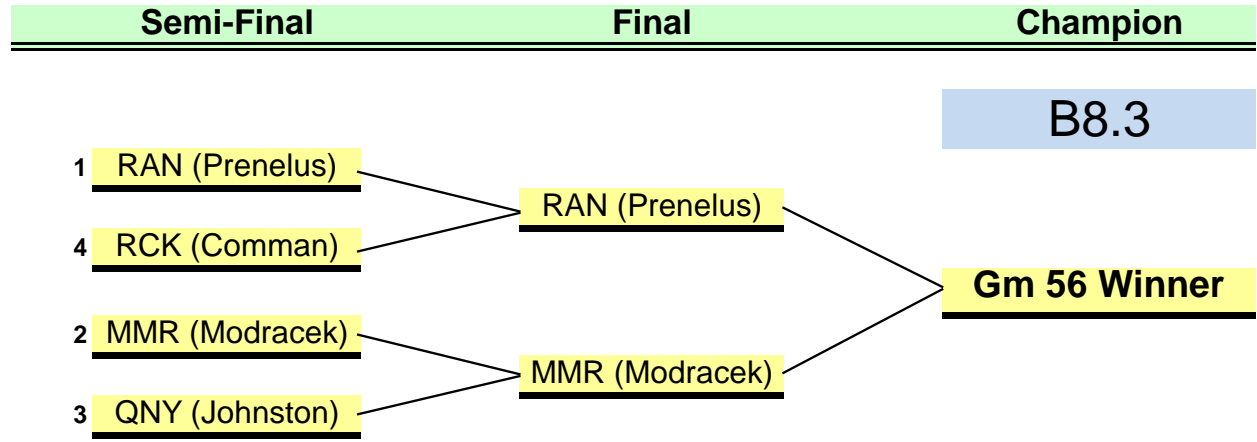

Seeds to be determined by Total Points

Last Updated: 6/15/19 6:48 PM

| Seed | B8.2 |
|------|------|
|------|------|

- 1 QNY (Bridges)
- 2 MMR (Wyman)
- 3 ABG (Spinney)
- 4 EBG (Mesheau)
- 5 WBG (Santiago-Callin)
- 6 ACU (Macaroco)
- 7 HOL (Clark)
- 8 STO (Teixeira)

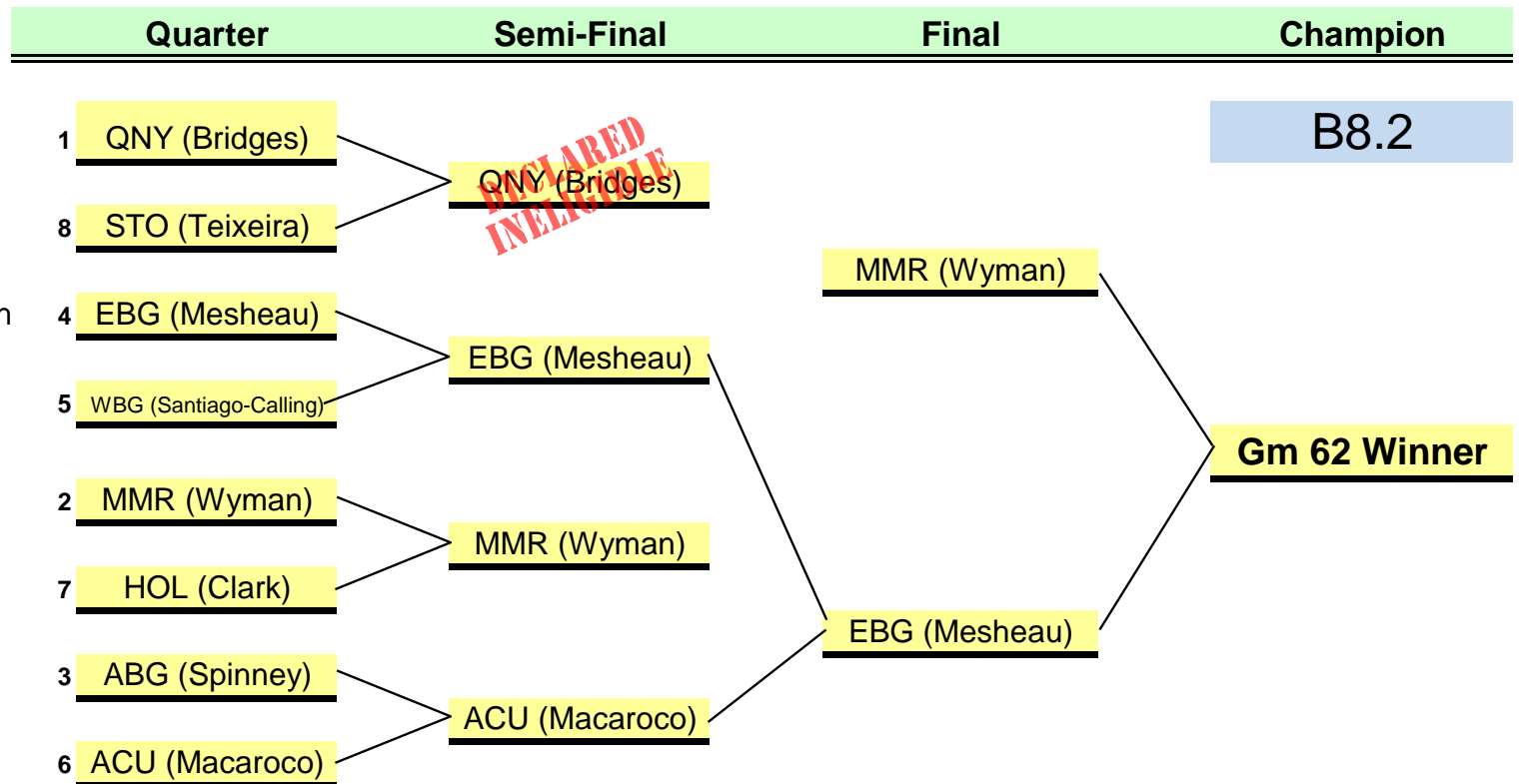

Seeds to be determined by Total Points

Last Updated:
6/15/19 6:48 PM

| Seed | G8.1 |
|------|------|
|------|------|

- 1 WEY (Reilly)
- 2 EAS (Pereira)
- 3 BRA (Wilson)
- 4 QNY (Gola)

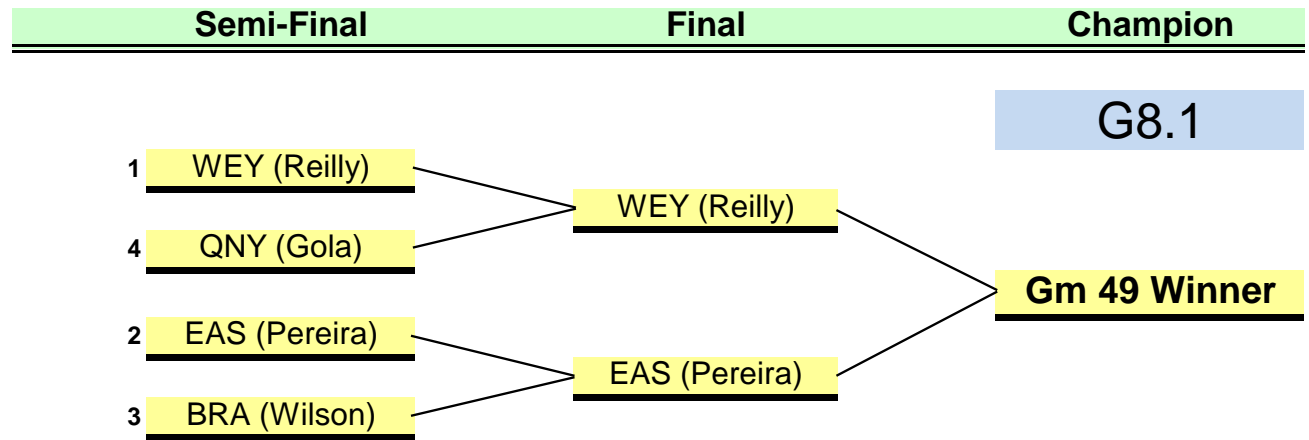

G8.1

Gm 49 Winner

Seeds to be determined by Total Points



| Seed | G8.3 |
|------|------|
|------|------|

- 1 EAS (DiPietro)
- 2 BRK (Olmstead)
- 3 QNY (Sampson)
- 4 WEY1 (Fisher)

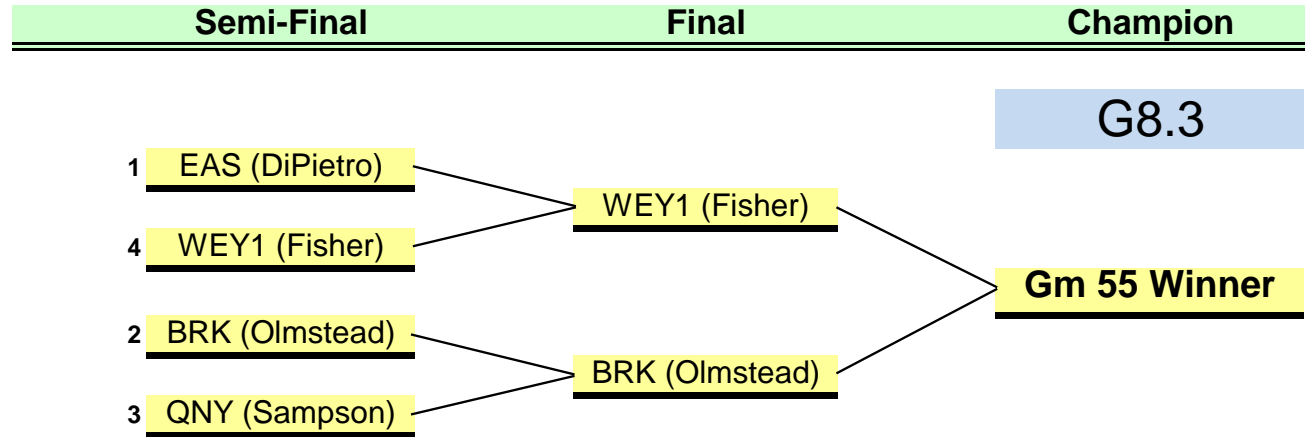

G8.3

Gm 55 Winner

Seeds to be determined by Total Points

Last Updated: 6/15/19 6:48 PM

| Seed | G8.2 |
|------|------|
|------|------|

- 1 RCK (Proctor)
- 2 WBG (Gately)
- 3 SHA (Soby)
- 4 WHT (Frank)
- 5 BRA (Firicano)
- 6 STO (Durand)
- 7 EAS (Schwarz)
- 8 BRK (Nieves)

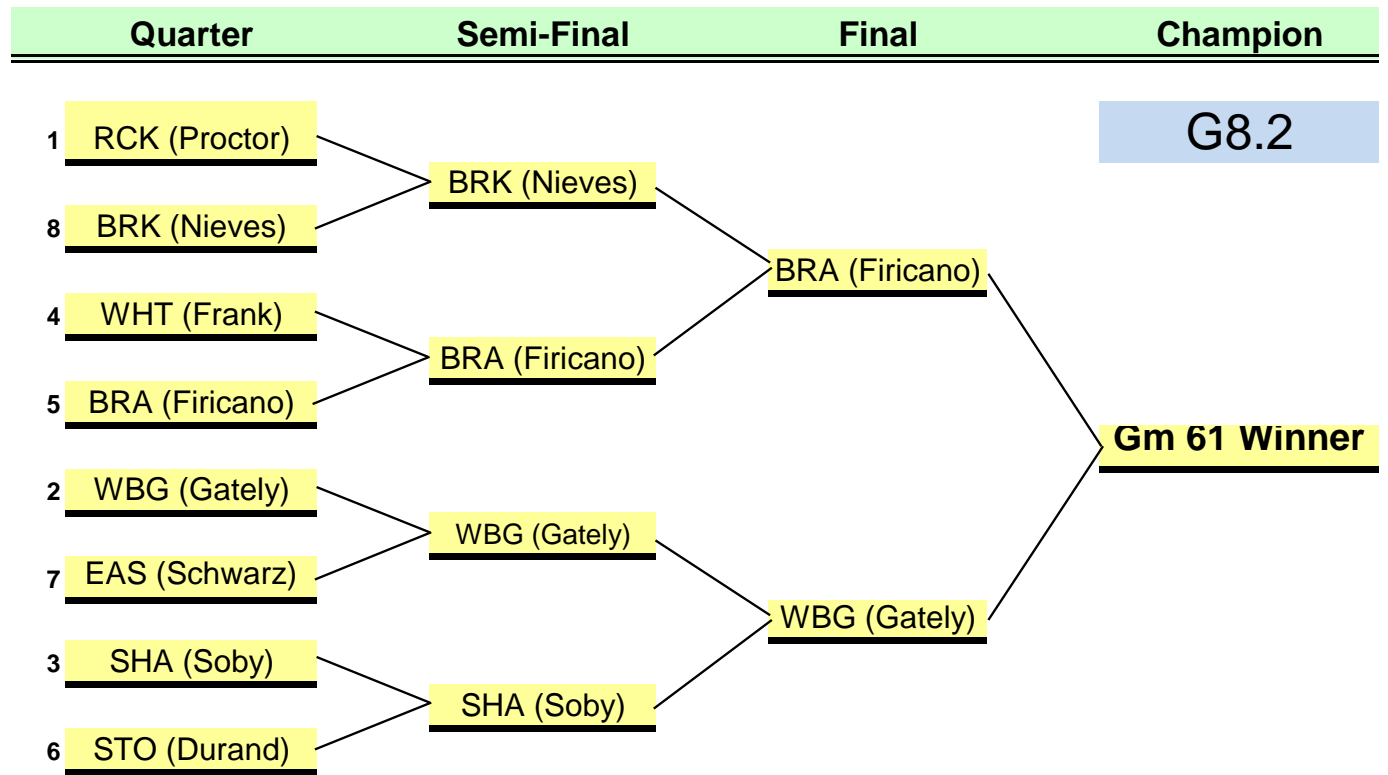

Seeds to be determined by Total Points

Last Updated: 6/15/19 6:48 PM

| Seed | B6.1 |
|------|------|
|------|------|

- 1 BRA (Smith)
- 2 BRK (Fontes)
- 3 QNY (Mergel)
- 4 ACU (Nunes)

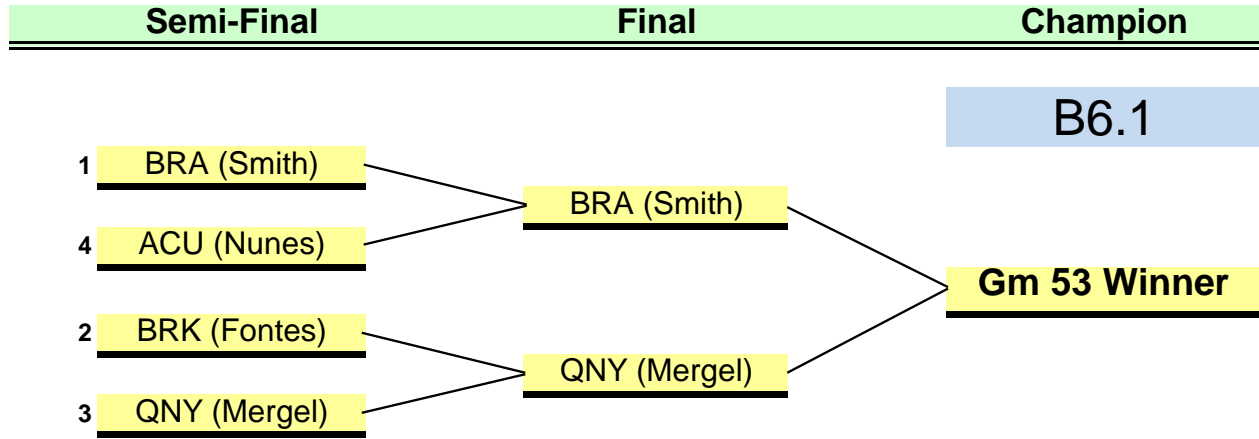

Seeds to be determined by Total Points

| Seed | B6.3 |
|------|------|
|------|------|

- 1 WBG (Maher)
- 2 BRA2 (Romero)
- 3 SHA (Scarfo)
- 4 QNY (Cavicchi)

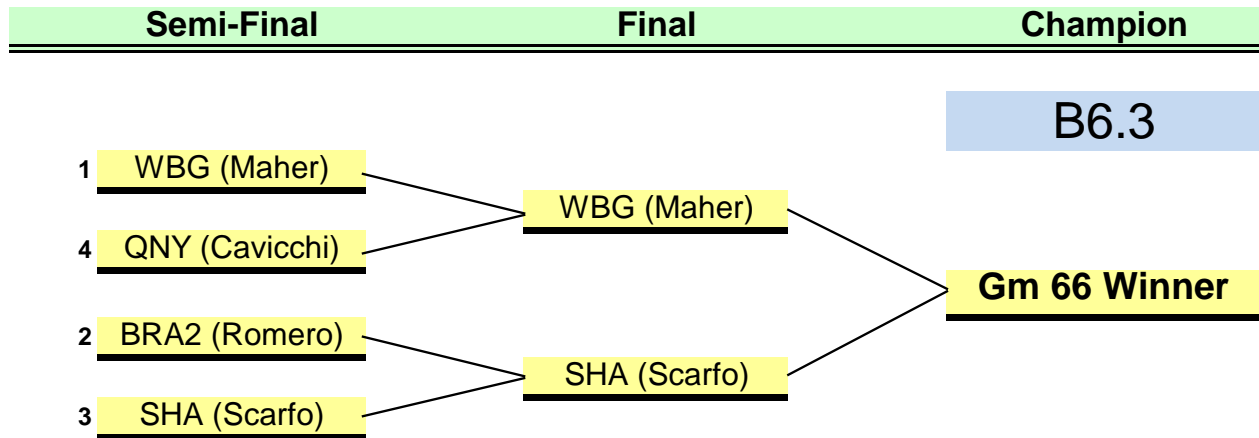

Seeds to be determined by Total Points

Last Updated: 6/15/19 6:48 PM

| Seed | B6.2 |
|------|------|
|------|------|

- 1 ABG (Grafton)
- 2 WHT (Murray)
- 3 EBG (McCarthy)
- 4 RCK (Harlow)
- 5 RCK (Comman)
- 6 RAY (Beckwith)
- 7 RAN (Myrthil)
- 8 ACU (Borges)

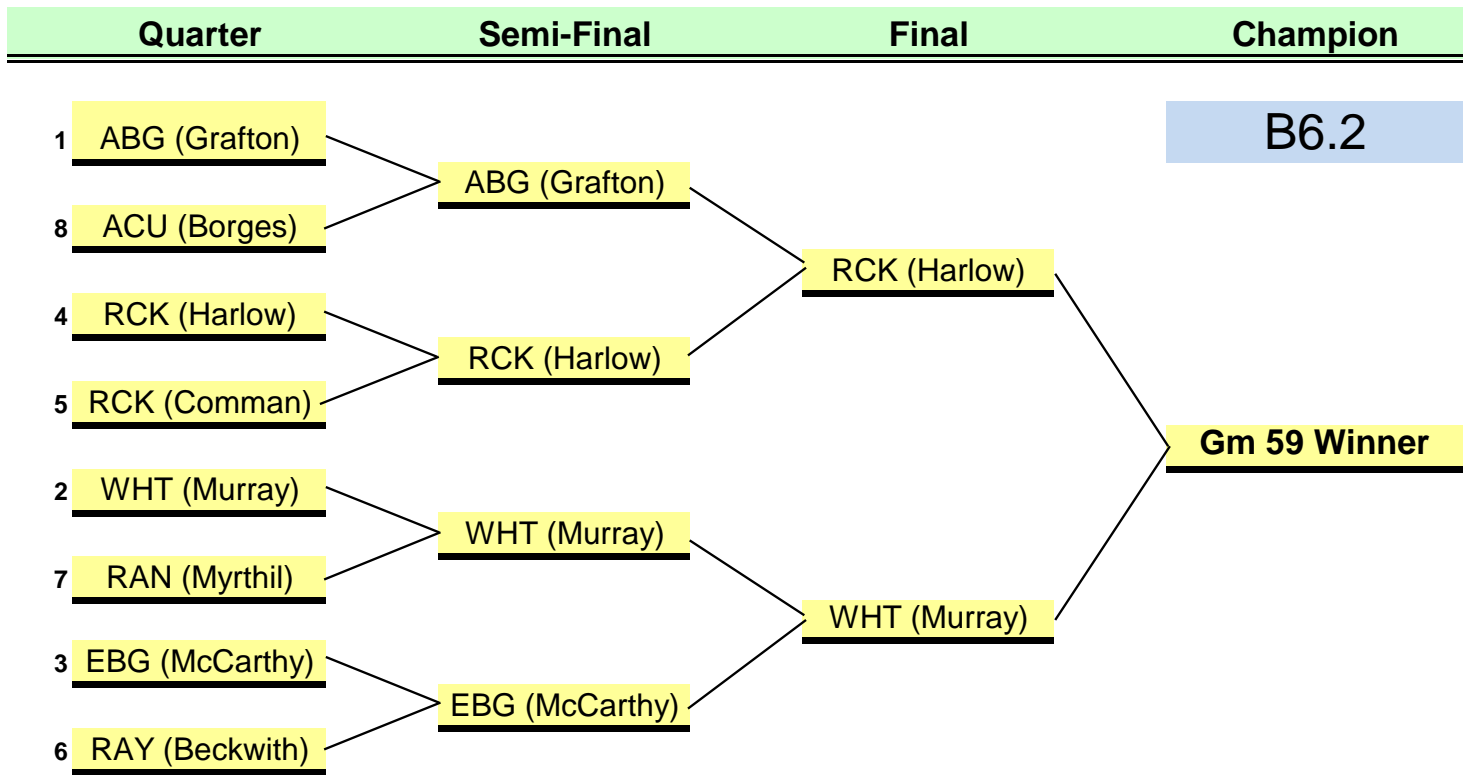

Seeds to be determined by Total Points

Last Updated: 6/15/19 6:48 PM

| | |
|-------------|-------------|
| Seed | G6.1 |
|-------------|-------------|

- 1 BRA (O'Sullivan)
- 2 WEY (Fuller)
- 3 BRG (Smith)
- 4 STO (Fox)

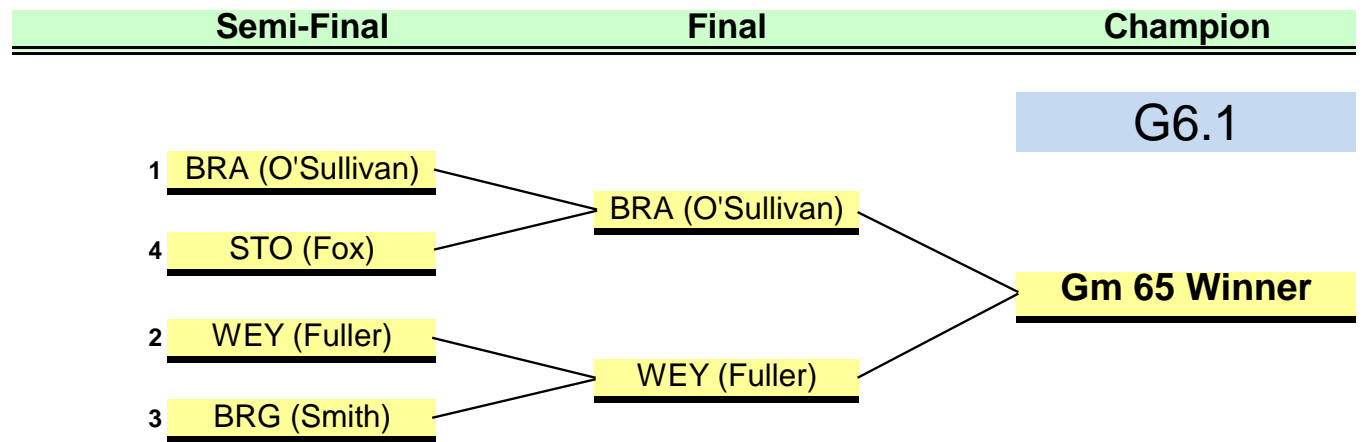

Seeds to be determined by Total Points

| | |
|-------------|-------------|
| Seed | G6.3 |
|-------------|-------------|

- 1 MMR (Feeney)
- 2 STO (Smith)
- 3 EAS (Barth)
- 4 QNY (Cary)

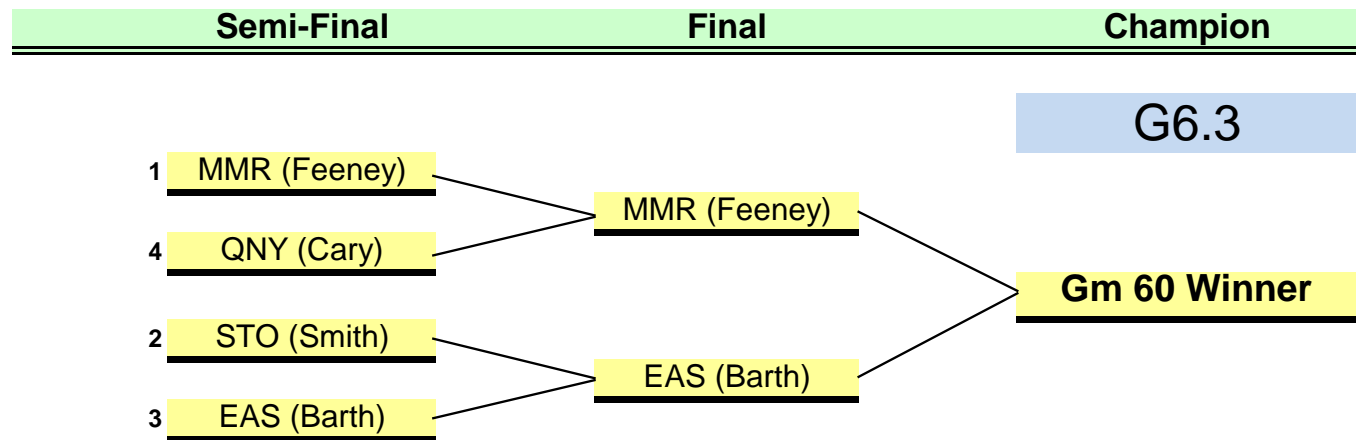

Seeds to be determined by Total Points

Last Updated: 6/15/19 6:48 PM

| Seed | G6.2 |
|------|------|
|------|------|

- 1 WHT (Fitzgerald)
- 2 HAN (Chapman)
- 3 EAS (Gamble)
- 4 RCK (Hennessy)
- 5 WBG (Morash)
- 6 BRA (Ranieri)
- 7 BRG (Beane)
- 8 MMR (Cardinal)

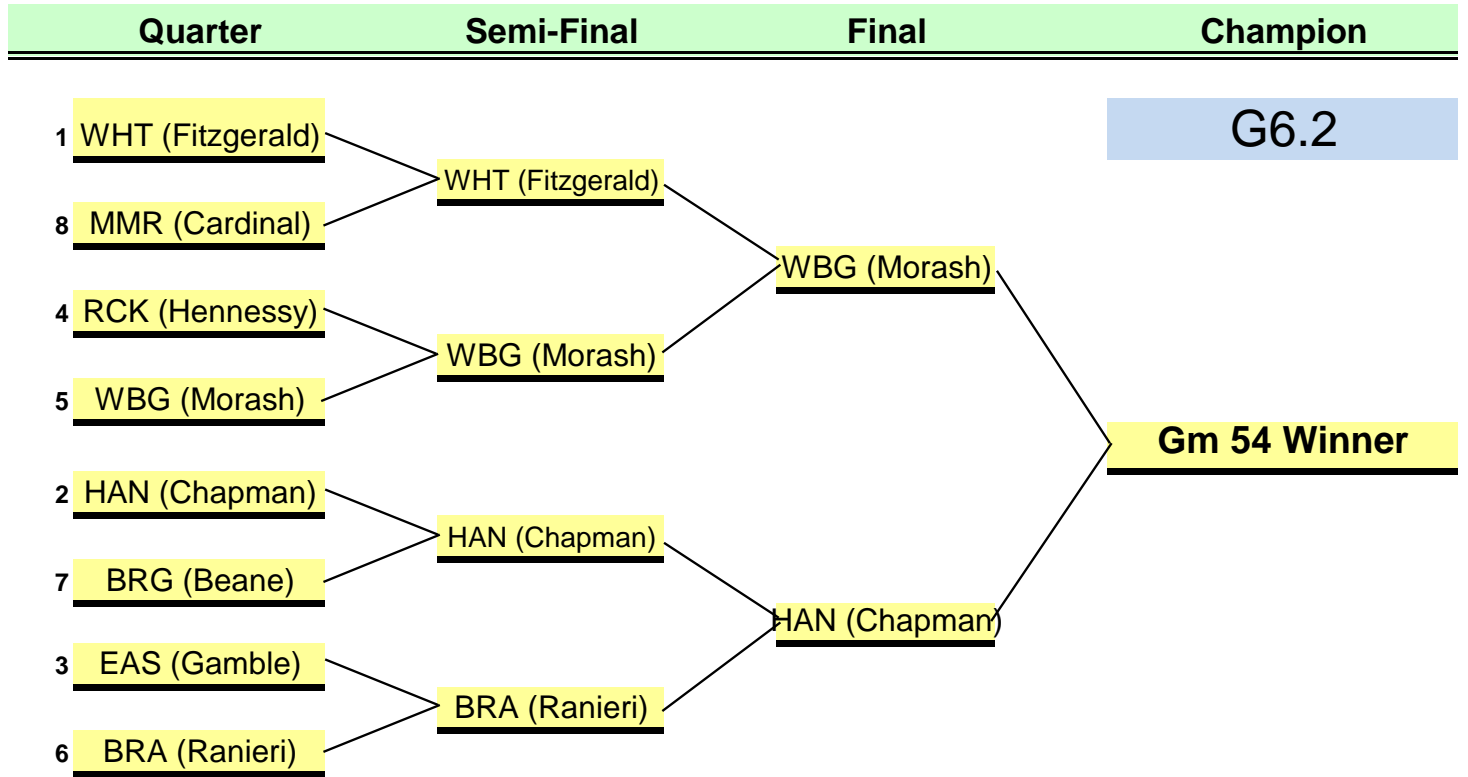

G6.2

Gm 54 Winner

Seeds to be determined by Total Points

Last Updated: 6/15/19 6:48 PM